

990 Series - Specification chart

990 SERIES - Multi-function mortice lock

Specifically designed for the Australasian market, the 990 multi-function case and reversible stainless steel latchbolt, allow easy conversion between functions and handing, without disassembly. Accompanied by a 10 year warranty, it is ideally suited for commercial, industrial, institutional and government buildings, where durability and security are of major importance.

- Lock conforms to level D3 (durability) and S2 (physical security) of the Australian Lock Standard (#AS4145.2-1993).
- Successfully tested over 4 hour period on fire-door assemblies as specified in Aus/NZ Standard AS/NZS 1905.1-1997 Part 1 Fire Resistant Doorsets.
- Case made of high purity zinc alloy, major internal components are brass or sintered steel/copper alloy giving durability, precision and strength.
- Case accepts bolt-through fixing for 50.8 diagonal and horizontal fixing for 38 - 41mm door furniture. Follower accepts 7.6 - 8mm spindles with no adjustment needed.
- Compatible with most electric strikes.
- ISO 9001:2000 company accreditation



DOOR TYPE
Metal or Wood

DOOR THICKNESS
32 - 50mm standard (thicker options available)

BACKSET
60mm standard, 70mm, 89mm and 127mm available

FIRE RATED
2 hours standard, 4 hours available

Selection Procedure

- Select series according to general function, eg. V SERIES - Vestibule Lock for Metal or Wood
- Select required key function eg. No outside key
- Select final lock function eg. Exterior & Exit Lock (Code V41)
- Select desired door furniture & finish eg. 503/514 (Legge Pacific 500 Series), Alessandro (Lever design), Chrome Plate (finish)

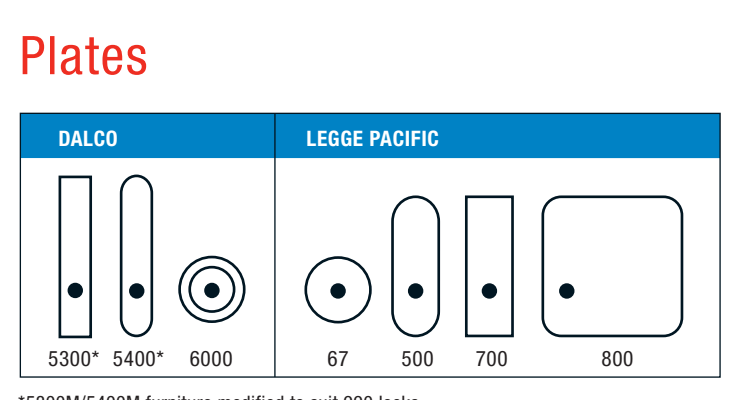
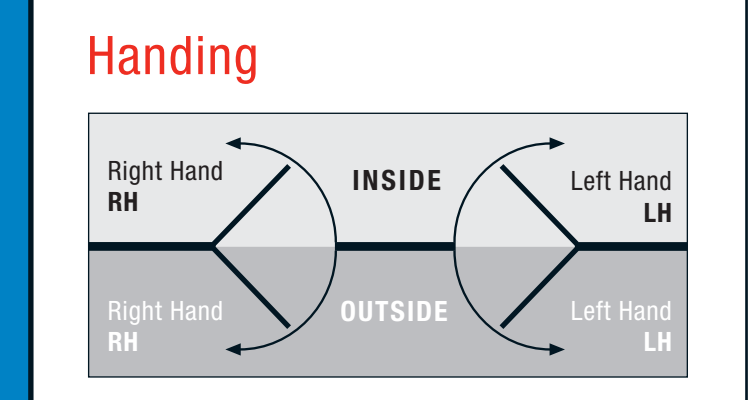

Levers

Available in Chrome Plate (CP), Polished Brass (PB) and Satin Chrome Plate (SCP).
Price on application for other finishes and finish combinations. (Dalco 6000 Series pictured)

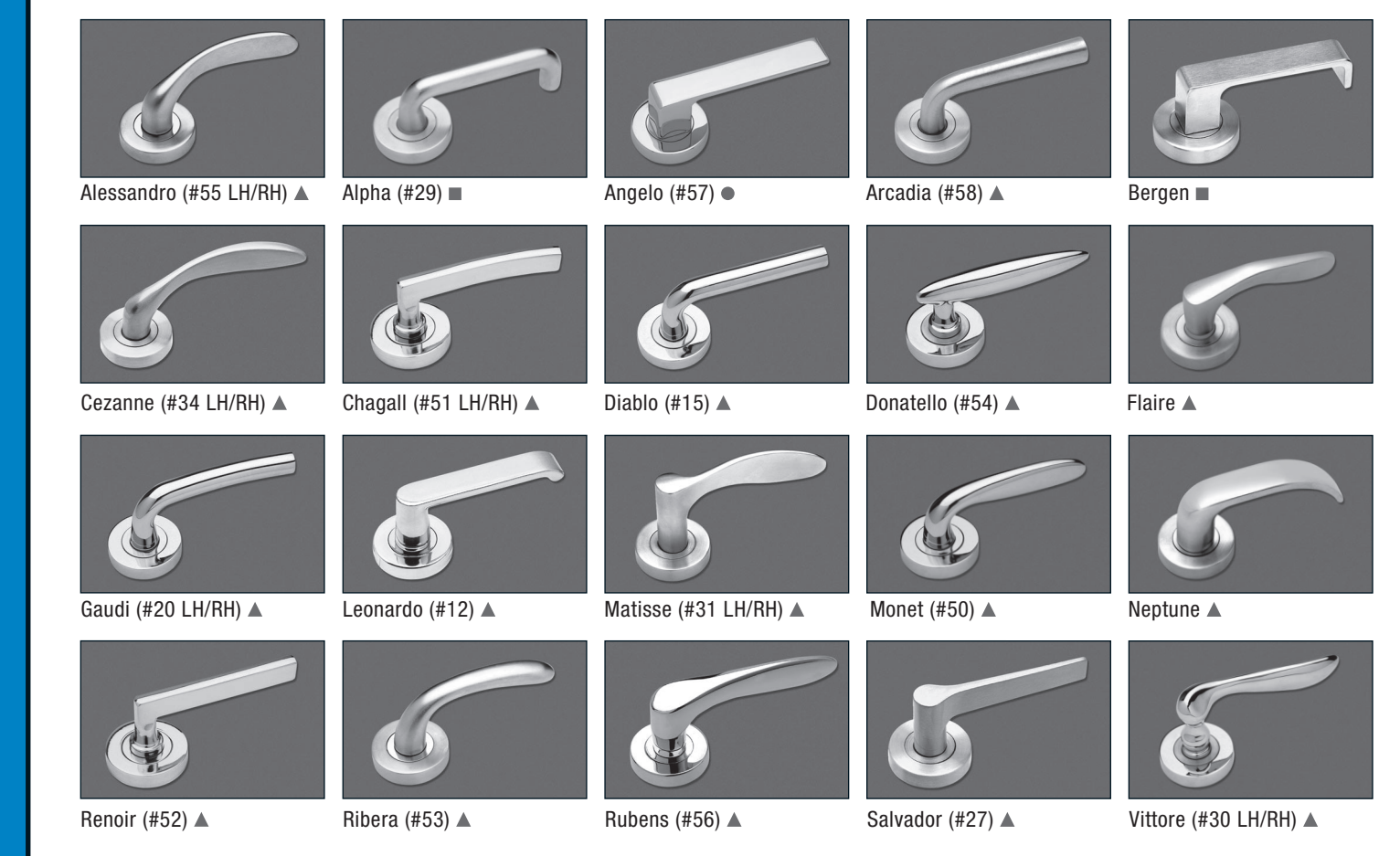

Functions

To convert the 990MF lock case to specific functions you will require the appropriate cams/cam adaptors (shown opposite), as well as the following accessories:

- V SERIES - Vestibule Locks:** Converts to all V Series functions except V25/26 Anti-Lockout lock. This function requires the anti-lockout lath (990-6A) and anti-lockout cam adaptor #4 (990-33).
- C SERIES - Combination Locks:** Converts to all C Series without any additional components.
- CD SERIES - Combination / Dual Deadlocking:** To convert to CD Series replace locking bar with CD Locking Bar (990-26D).
- N SERIES - Nightlatches:** To convert to N Series, remove both followers, locking bar assembly, handle return spring & bar. Fit night-latch follower (990-20N) and night-latch lath (990-6N).
- D SERIES - Deadlocks**
- S SERIES - Sliding Door Locks**

Cams and thumbturn adaptors

The required cam number for each function is shown next to the cylinder or turn in the chart adjacent.

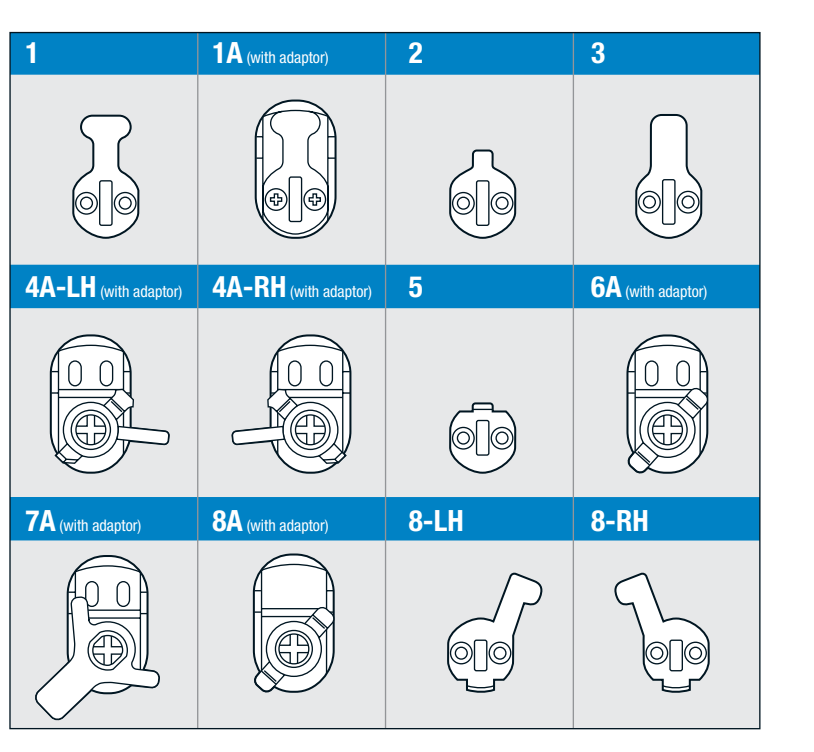

V SERIES - Vestibule locks

OUTSIDE KEY OPERATES BOLT AT ALL TIMES

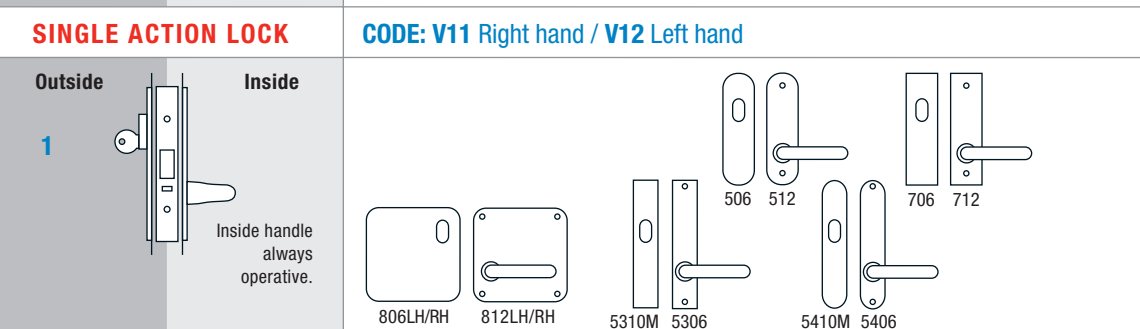
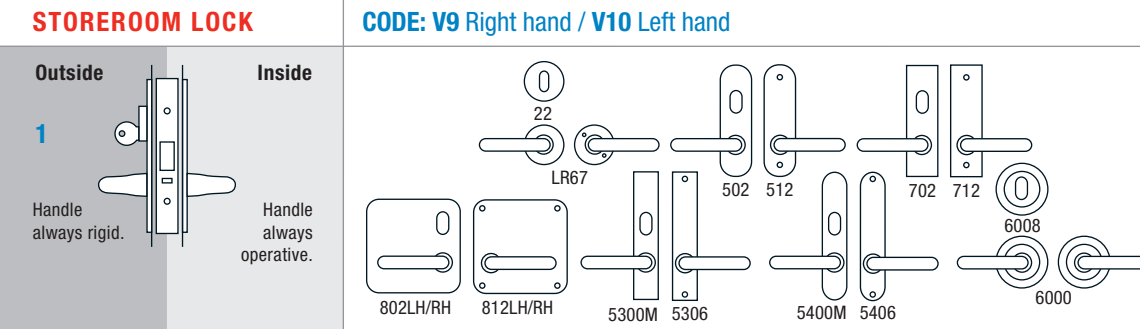
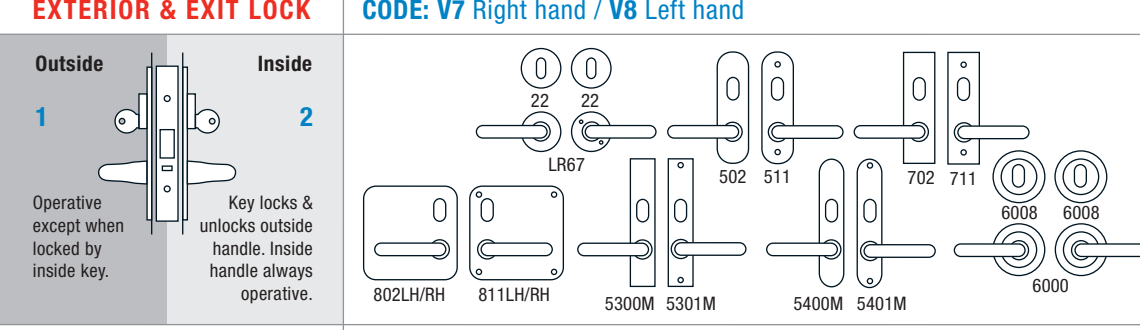
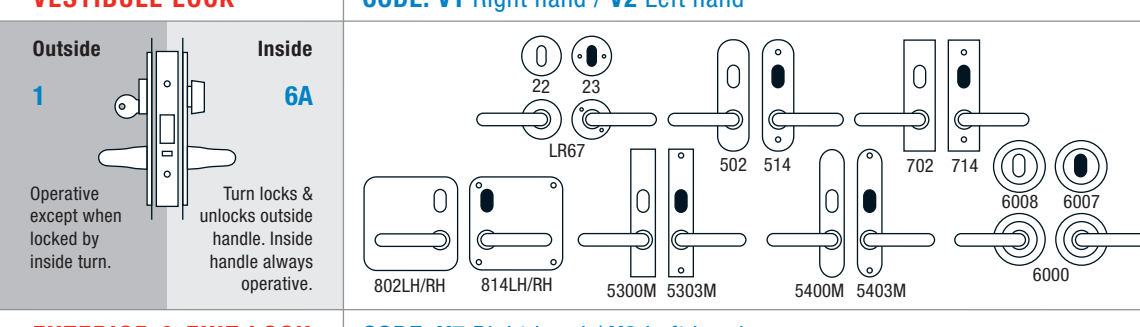

OUTSIDE KEY LOCKS AND UNLOCKS OUTSIDE HANDLE

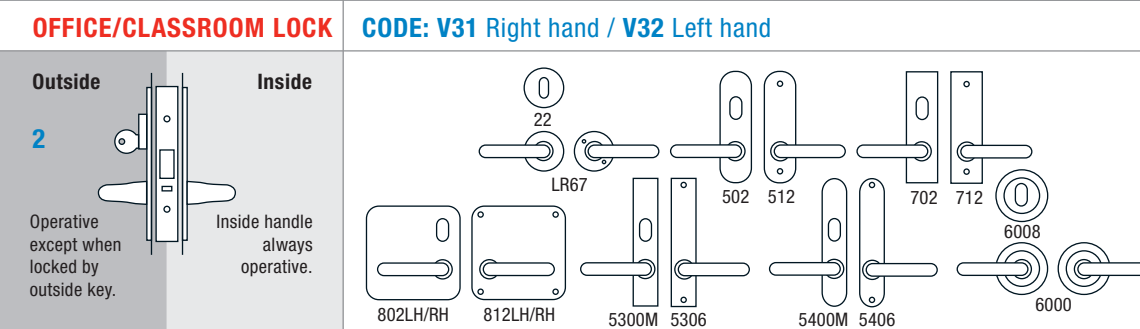
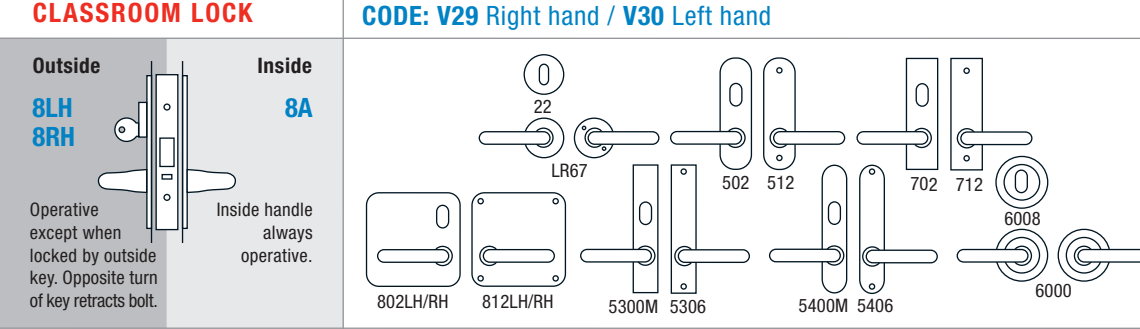
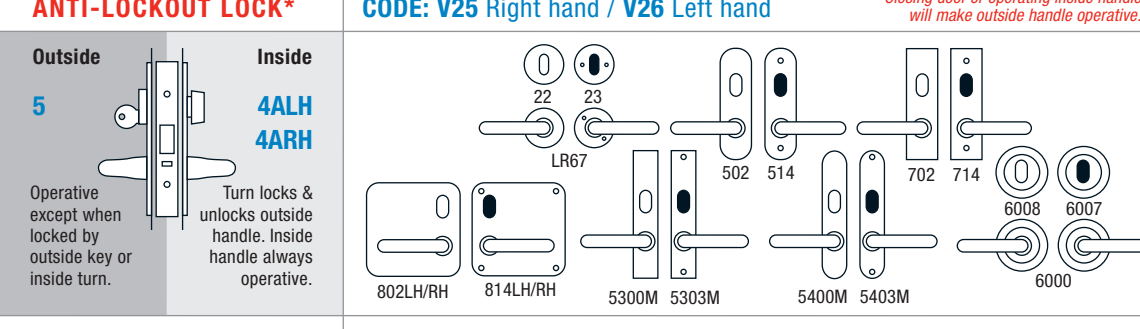
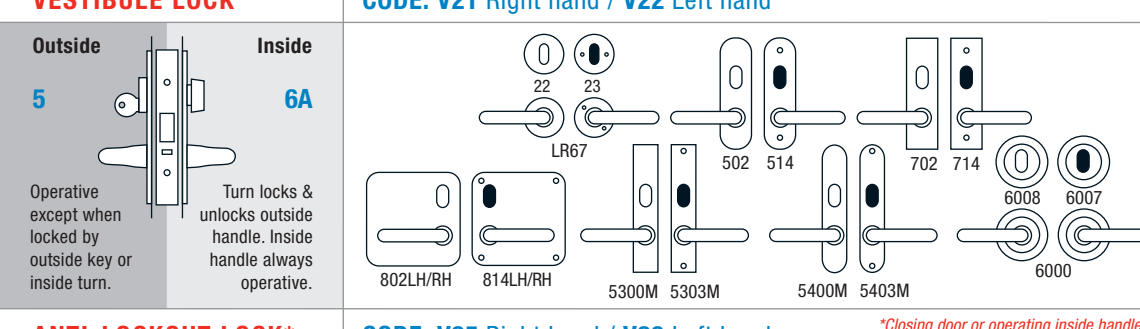

NO OUTSIDE KEY

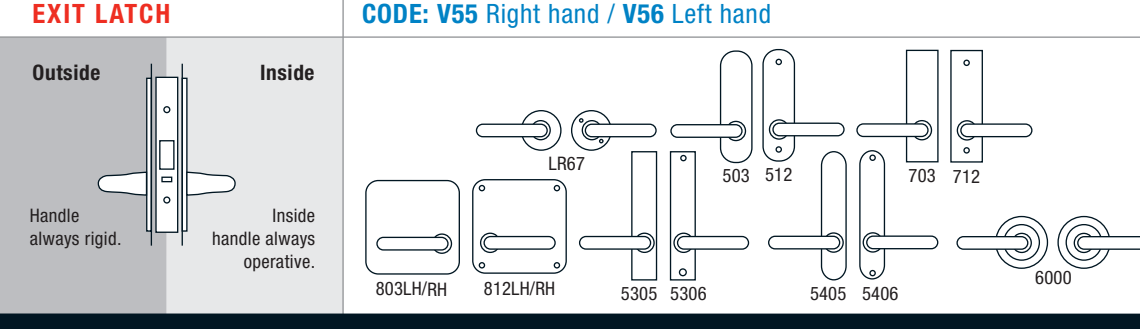
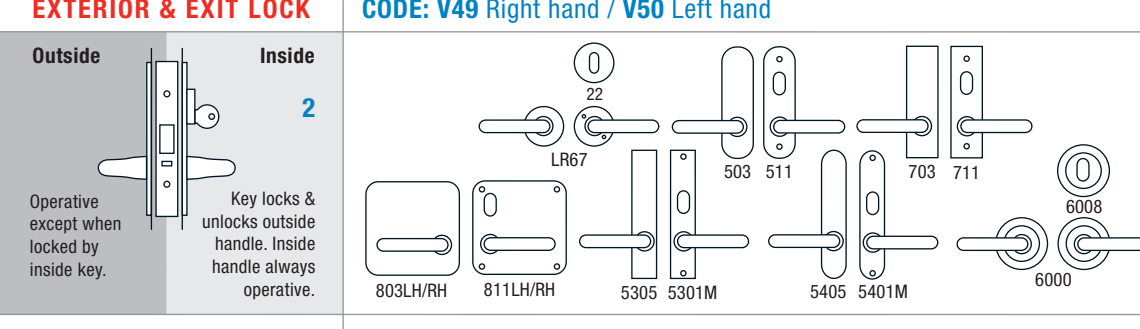
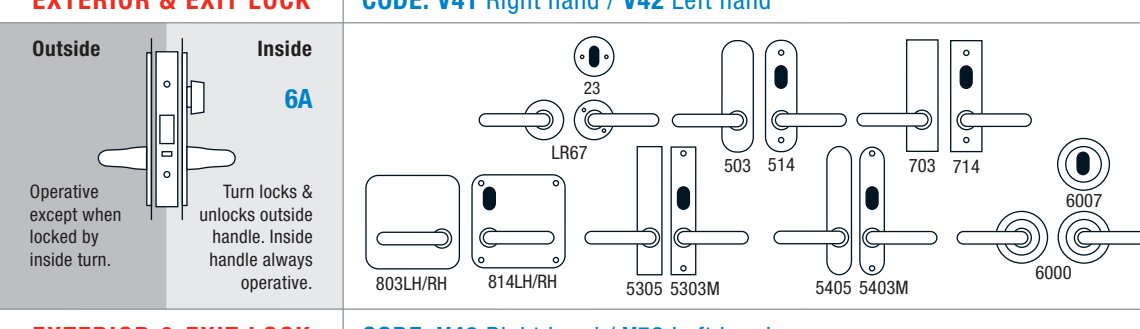

C SERIES - Combination locks

OUTSIDE KEY OPERATES BOLT AT ALL TIMES

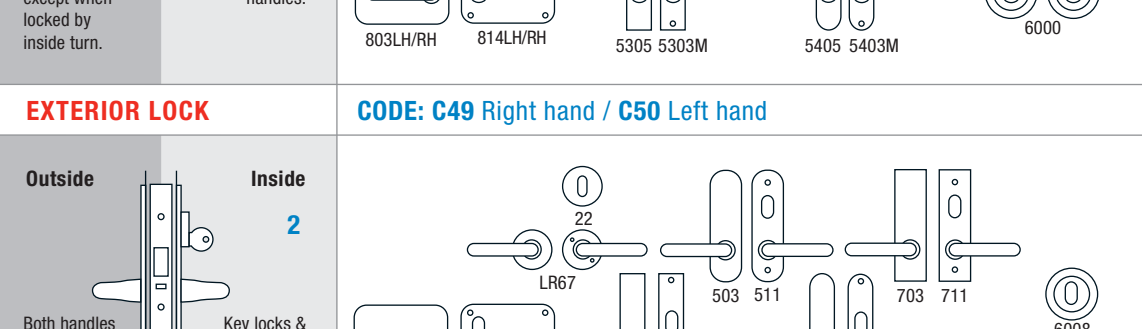
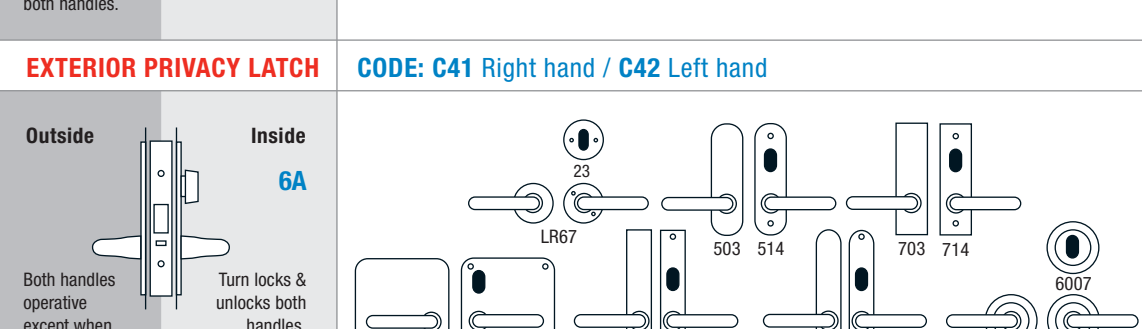
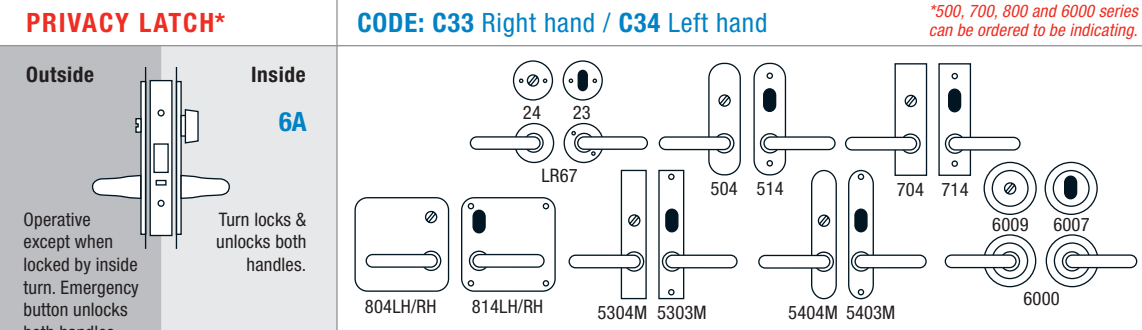
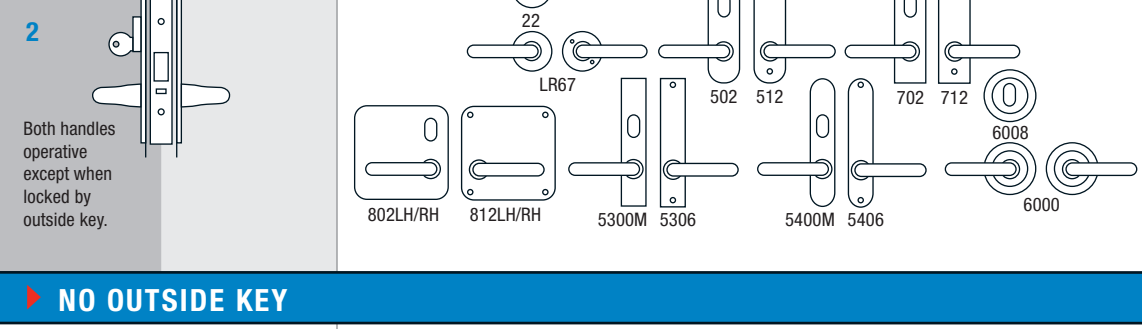
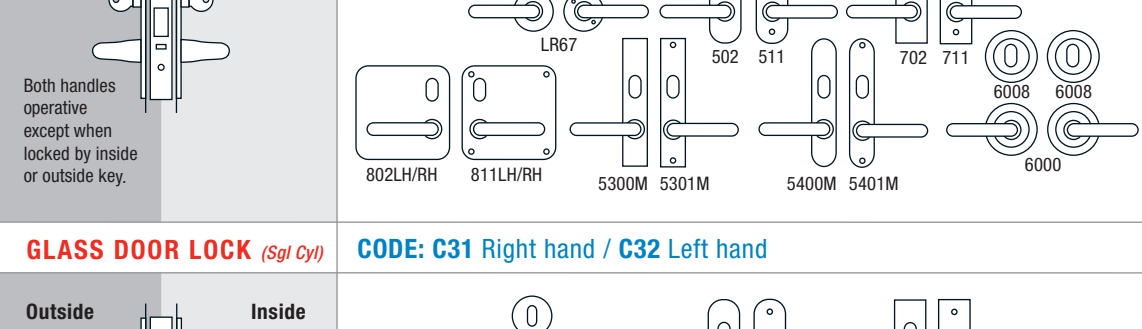
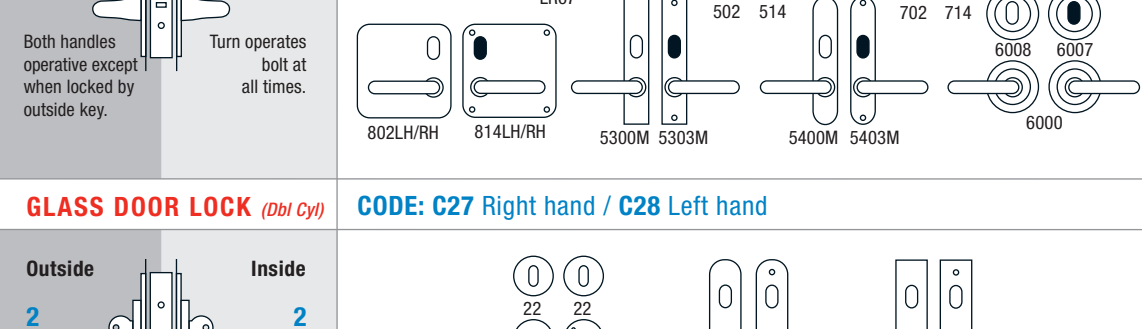
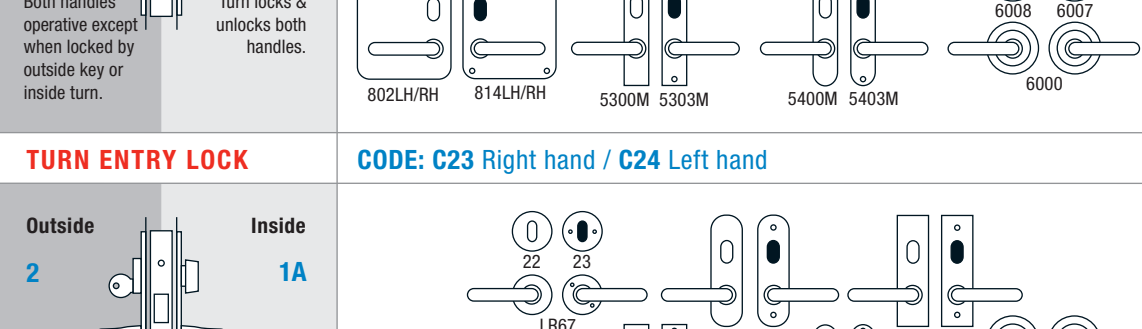
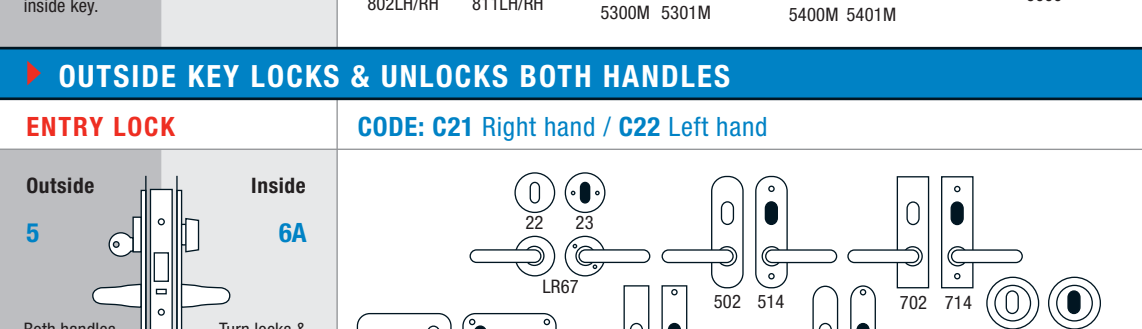
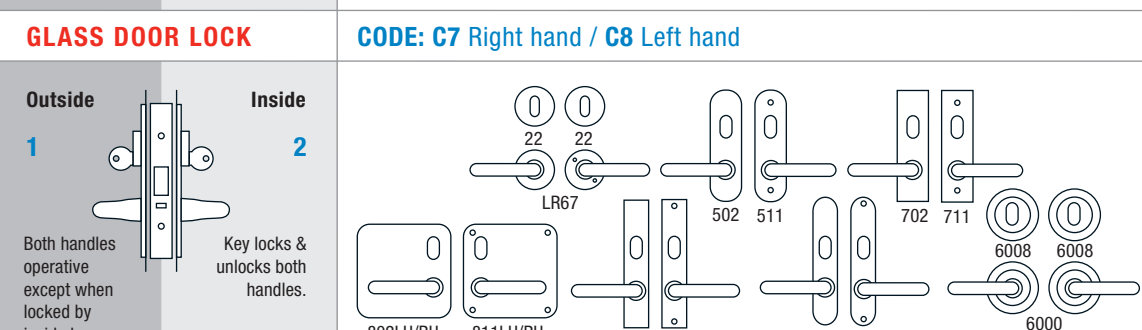
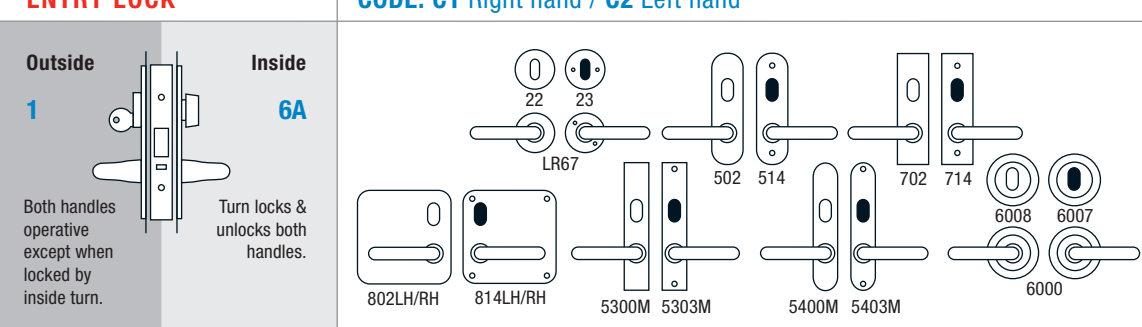

CD SERIES - Comb. / Dual Deadlocking

OUTSIDE KEY LOCKS & UNLOCKS BOTH HANDLES

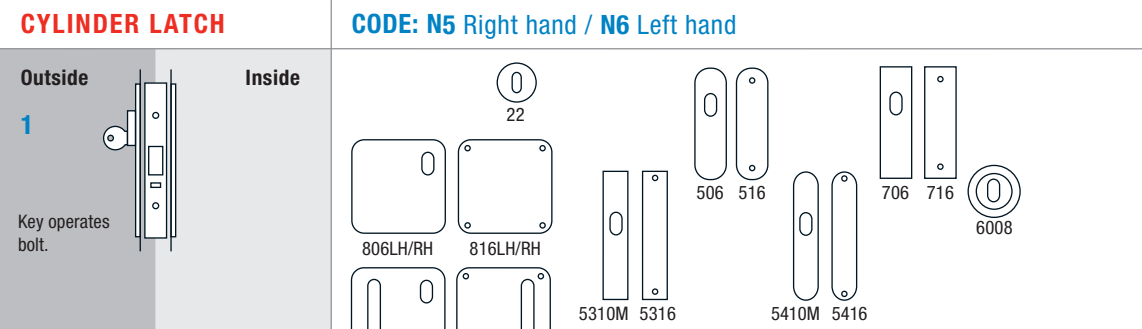
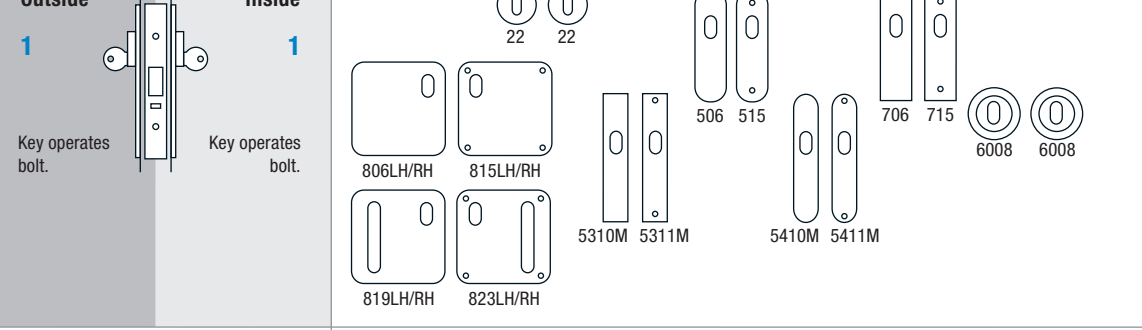
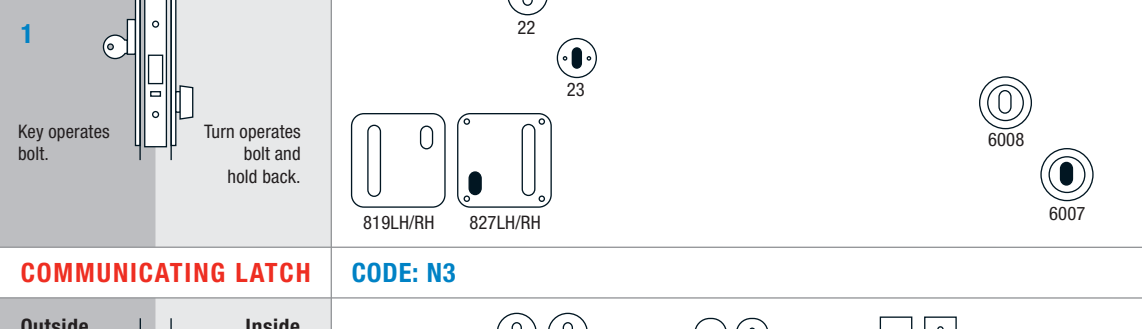
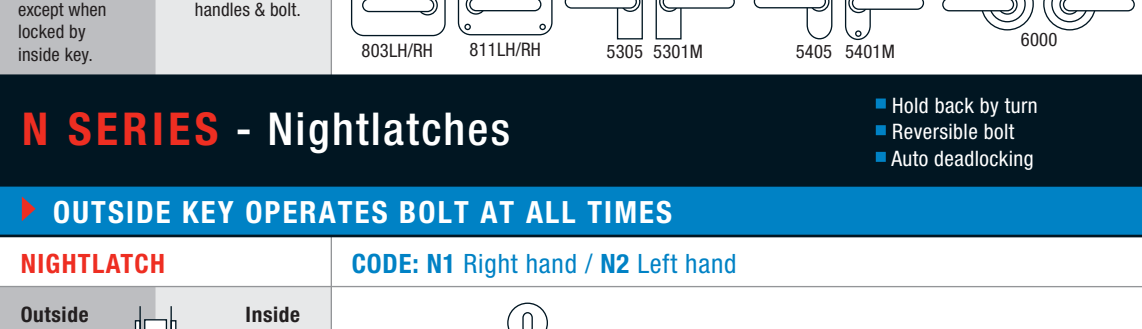
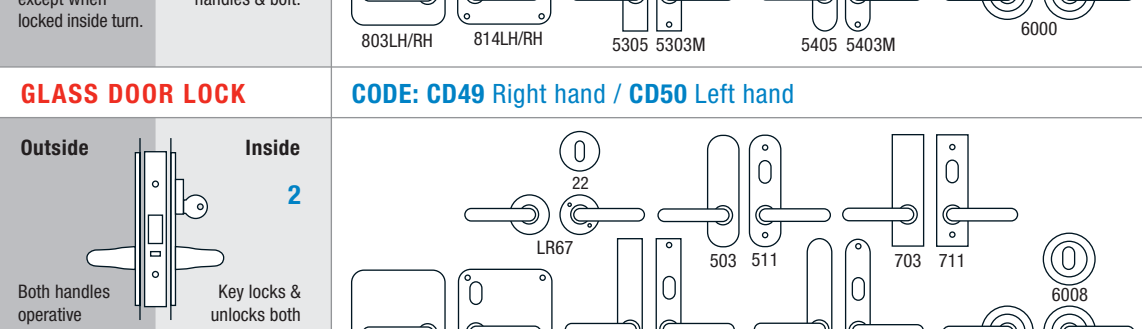
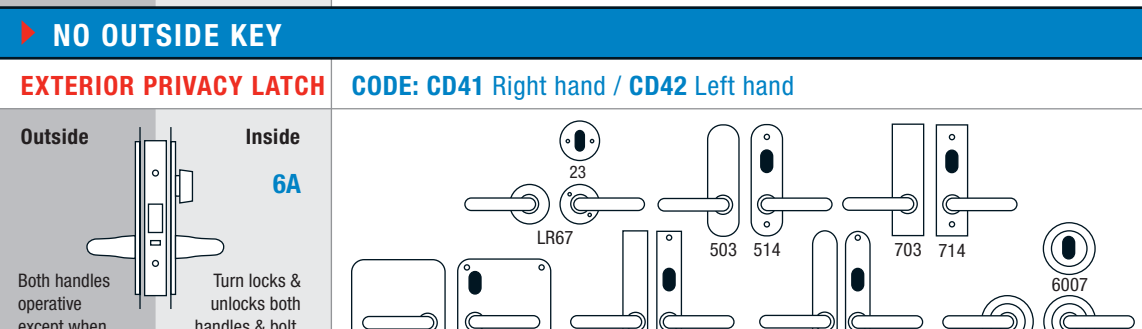
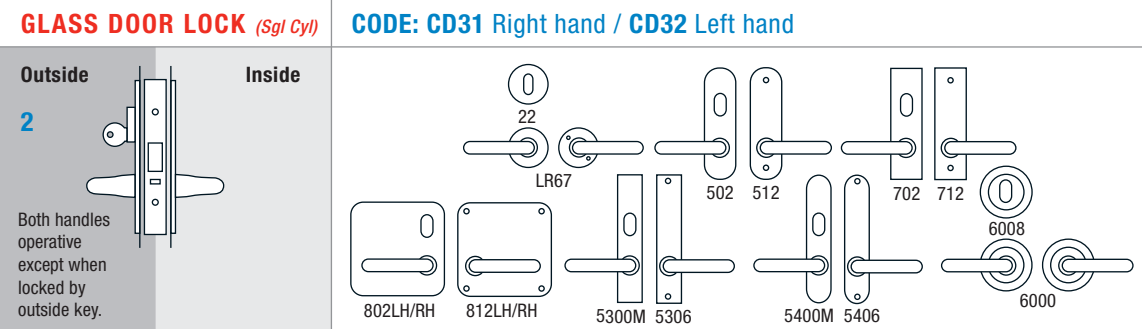
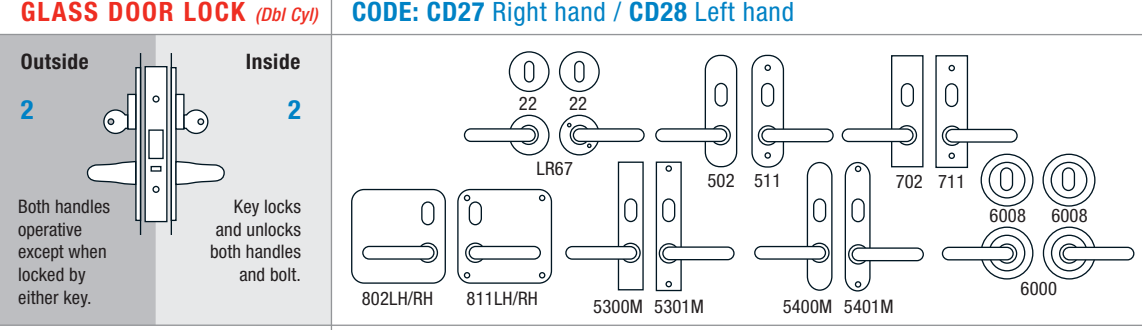
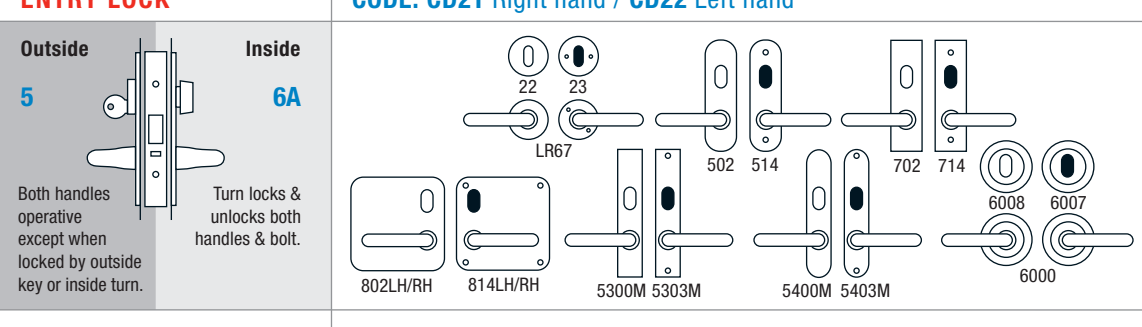

D SERIES - Deadlocks

OUTSIDE KEY OPERATES BOLT AT ALL TIMES

